

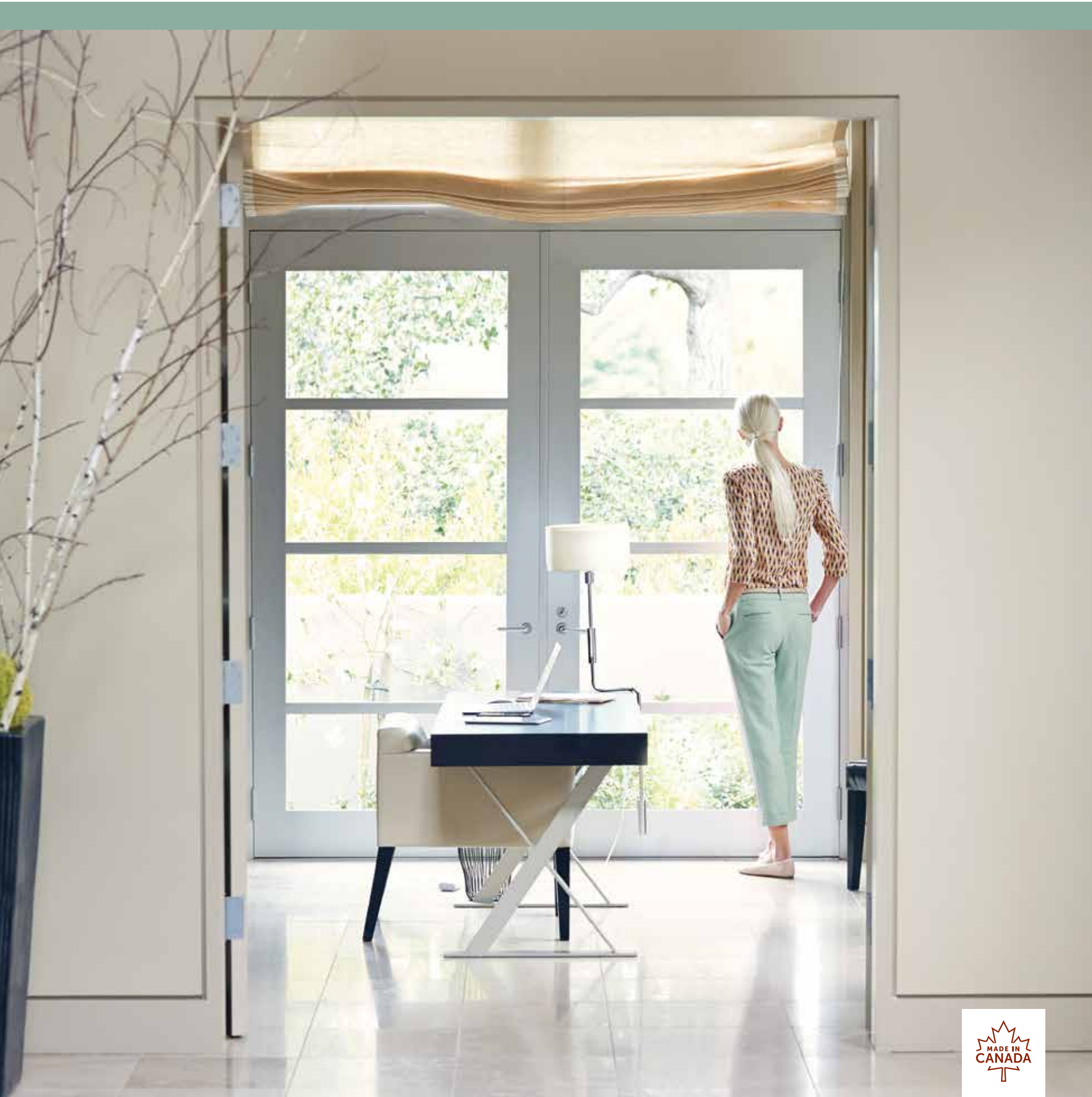

LEADERS IN QUALITY, STYLE & PRESTIGE SINCE 1969

WINDOWS & DOORS





INNOVATION
AND
INSPIRATION
IN OUR PRODUCTS
AND OUR PEOPLE

WELCOME

Lux Windows and Glass Ltd. offers the most complete line of windows and doors available anywhere in Western Canada.

Our products meet the highest standards of durability, reliability and aesthetic appeal, and our windows are designed to withstand Canada's winter climate. We continually strive to manufacture the best windows and doors possible and service our clients with unparalleled care and commitment to quality.

Crafted specifically for your home and style, every window and door bears our hallmark attention to detail. **This is Lux Windows.**



Certified Products

As a proud, certified ENERGY STAR member, Lux has developed a broad range of environmentally-friendly products.

ENERGY STAR products are among the most energy-efficient on the market and are proven to reduce energy consumption and exterior noise while minimizing condensation, blocking ultraviolet rays and reducing greenhouse gas emissions.





STORY

From our family to yours. For over 45 years, Lux has been renowned for exceptional windows and doors built upon innovative thinking and old-world craftsmanship.

**Look
Inside to
Find**

HISTORY
& LEGACY
THE LUX
DIFFERENCE
AND MORE...



HISTORY & LEGACY

We take great pride in our role as industry leaders and are wholly committed to creating a class of products that endure for a lifetime. Throughout our history, we've held ourselves to the highest possible standards, developing cutting-edge technologies and earning a reputation for exceptional customer service. Today, we are a multi-generational family business with both an unrivaled record and a bright future.

Lux Windows and Glass Ltd. was founded in 1969 with just five employees in a small shop in Calgary. Now, with a 105,000 sq. ft., state-of-the-art manufacturing facility, our experienced team of more than 150 engineers, installers, craftsmen, carpenters and sales professionals is committed to ensuring our customers are always completely satisfied. This commitment to care and attention is, and always has been, the hallmark of our family business.

We pride ourselves on combining the best of today's new technology with an old-world commitment to craftsmanship. Our goal is to offer renovators, builders, architects, designers and homeowners quality, craftsmanship and service at competitive prices in both the residential and commercial markets.

Over the years, Lux Windows has grown consistently, and we now proudly serve clients in Western Canada, the United States, Australia, Asia and Europe. All the while, we have remained firmly connected to our community, where our unmatched reputation is deeply important to us; because at Lux, delivering true quality is about more than a business' reputation, it's our family's way of life.



A Family Legacy

Lux owners John Petrillo and Tony Ambrogiano came to Canada in the 1950s. Shortly after, they developed a keen interest in the glass industry, coupled with a strong work ethic. Today the brothers-in-law have ensured a continued legacy of excellence by passing their skills and knowledge onto their children.



THE LUX DIFFERENCE

Built by Neighbours, for Neighbours

Lux is a family-owned and operated business, and we are proud to fuel the local economy by manufacturing right here in Alberta. Our owners and employees live in the same communities as our customers and give back to those communities through various donations and sponsorships programs.

We believe that our most valuable resource is our team. The culture at Lux resembles the relationship of a close-knit family and of this we are very proud. Throughout our rapid growth, we have consistently maintained extremely low employee turnover rates. The long term commitment, dedication, and pride in workmanship shown by our team are the key factors behind our superior quality products.





WINDOWS

The clear choice
for an exceptional
selection of window
styles and materials,
all designed to let
the sun shine in.

Look
Inside to
Find

WINDOW
TYPES

ALUMINUM
CLAD SERIES

LYNX HYBRID
SERIES

PVC SERIES

SPECIALTY
WINDOWS

INTERIOR
JAMB



The Clear Choice

A World of Windows, Crafted with Signature Lux Quality & Style

From our classic and elegant Aluminum Clad Window, to the striking and smart LynX Hybrid and the cost-effective, low maintenance PVC Window, Lux Windows offers an exceptional selection of window styles and materials crafted with quality you can see.

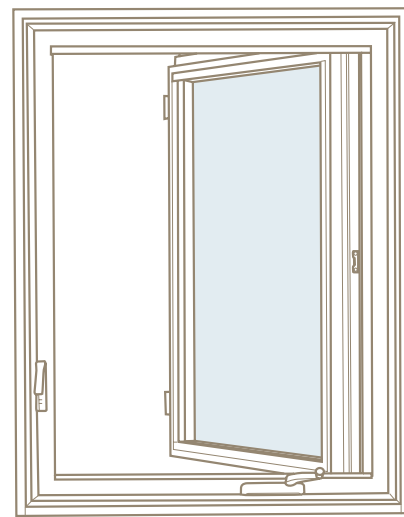

CASEMENT WINDOWS

Casement windows open in a similar fashion to a door, swinging out from the frame and easily controlling the desired ventilation.

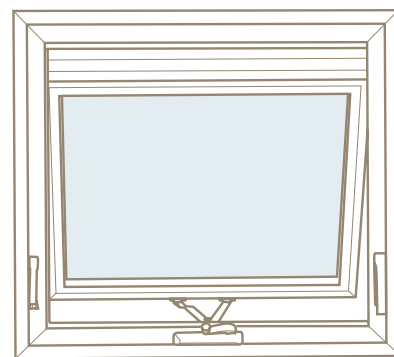

AWNING WINDOWS

Awning windows open from the bottom, allowing fresh air in while providing protection from precipitation outdoors.

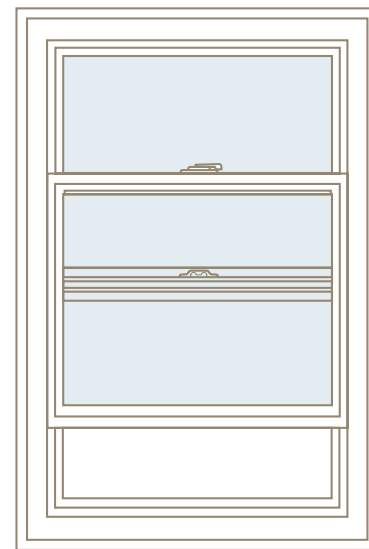

Vertical Slider Window

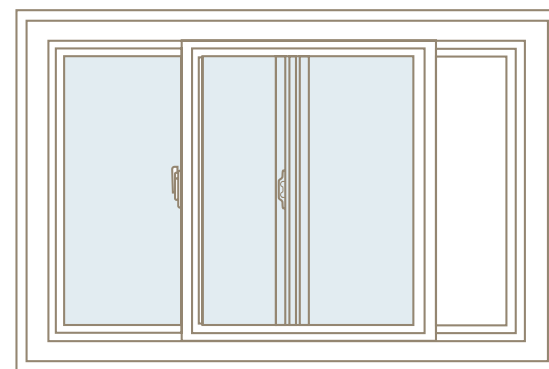

Horizontal Slider Window

SLIDER WINDOWS

With horizontal and vertical orientations available, sliding windows provide an abundance of light and easily regulated airflow. Available in LynX Hybrid and PVC Only.

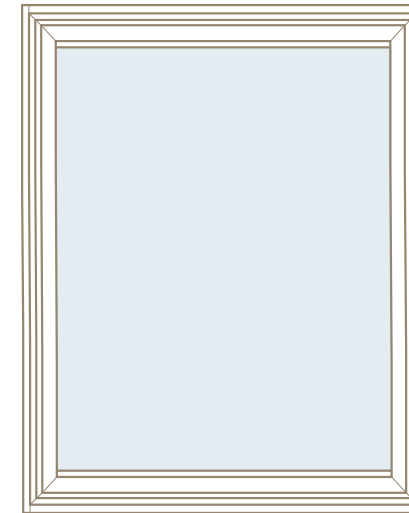

PICTURE WINDOWS

While they don't provide ventilation, picture windows maximize views through clean architectural lines. These windows lend themselves to countless design possibilities and shapes, as outlined in the "Custom Shaped Windows" section of this catalogue.

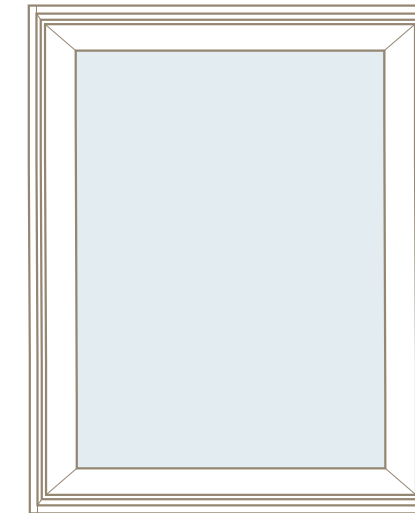

FIXED SASH WINDOWS

Fixed sash windows are a picture window with a non-operable sash, designed to create matching sightlines when paired with a casement or awning window to ensure a balanced appearance.

Fixed Sash vs Picture Casement

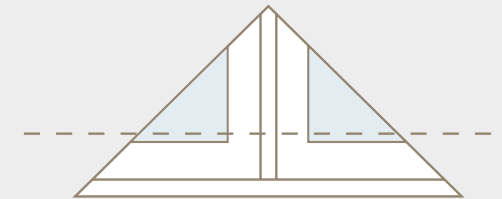

Fixed Sash / Casement

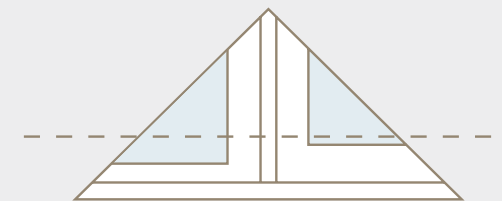

Picture / Casement







Aluminum Clad Window Series

Custom-built for your home, our aluminum clad windows are the perfect complement to any room. We offer endless design possibilities combined with a low maintenance exterior and a naturally insulating wood interior.

Lux developed an exclusive extruded chamber for the exterior of aluminum clad combination windows. This closed chamber is specifically designed to combat air and water infiltration where conventional methods typically fail.

FEATURES & BENEFITS

- A low maintenance exterior is available in virtually any custom colour or can be selected from our standard colours
- Combined with the beauty of a solid Hem/Fir interior, aluminum clad windows offer true versatility in design
- Extruded aluminum profiles provide a more durable exterior finish and eliminate the need for painting
- Aluminum brickmould options include 5/8", 2" and 3 1/2" (visual dimension), an integral nailing flange and corner gaskets
- Exterior glazed sealed units provide a far superior seal; conventional methods of interior glazing require an inside seam that has been found to compromise the window's integrity
- Structural stability through mortise and tenon joinery on the sash and rabbet joints on the frame
- No finger joints are used to protect from delamination which would allow water to penetrate the frame and building envelope
- Enjoy complete security and energy performance with Multipoint Encore®, a fully concealed, smooth operating casement locking system designed to provide exacting compression of the weather seal and window alignment in the frame
- An exclusive exterior closed chamber mullion cap that completely covers the seams of combination windows, provides aesthetic appeal and structural support while eliminating air and water infiltration

A Closer Look at the Aluminum Clad Windows by Lux

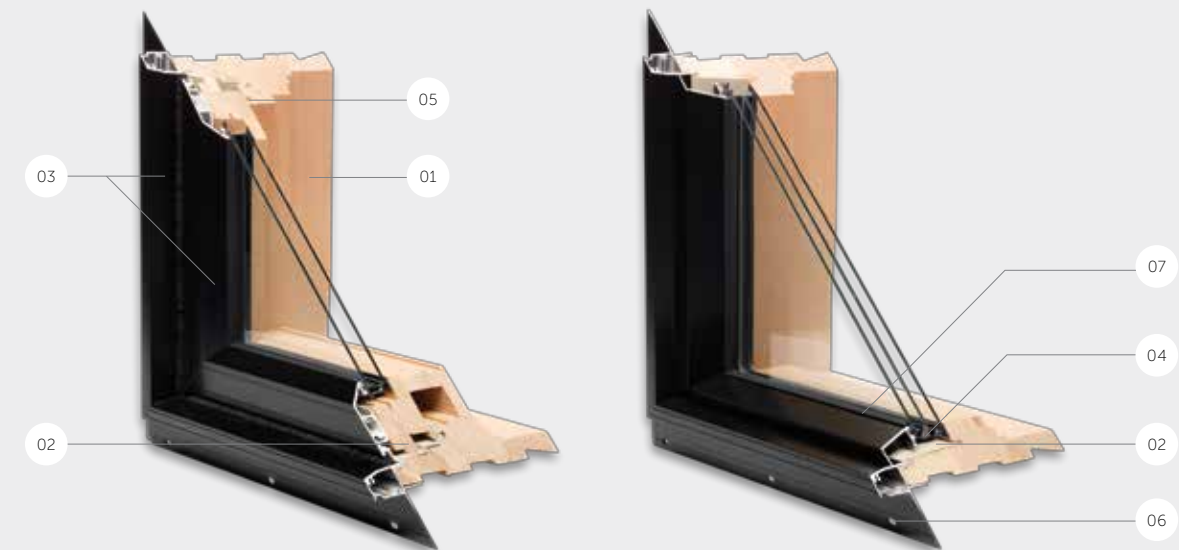

Aluminum Clad Casement & Awning Window Dual Glazed

Aluminum Clad Picture Window Triple Glazed

- 01 Solid Hem/Fir construction is the perfect combination of strength and extraordinary elegance
- 02 Four degree sloped sills and sashes of all aluminum clad windows. The sash cavity of all venting and non-venting windows where water damage would potentially occur is protected by a heavy walled vinyl liner that migrates water to the exterior and does not allow the water to come in contact and sit on the raw wood.
- 03 Extruded aluminum mainframe and sash—offers greater structural capabilities to withstand the tough elements of nature and eliminates the need for painting. The aluminum is independently secured allowing the wood and aluminum to expand and contract without restriction.
- 04 Endur IG™ ensures outstanding thermal performance and exceptional longevity. For more information about Lux glass and glazing options, see "Glass Performance."
- 05 Heavy duty compression foam seal making casements and awnings among the most energy efficient venting windows
- 06 Extruded integral nailing flange eliminates the risk of water and air infiltration between the nailing flange and the brickmould
- 07 A rubber gasket spline is a maintenance free solution to conventional caulking methods



LynX Hybrid Window Series

Beauty Meets Practicality

Lux's exclusive LynX Series of hybrid windows offers the benefits of both aluminum clad and PVC windows in one innovative window system. Durable and built to last, our signature line of hybrid windows comes in a wide range of colours and finishes, and with countless customization options to ensure your new windows are perfectly suited to your home.

FEATURES & BENEFITS

- Aluminum's strength with vinyl's efficiency
- Pairs perfectly with the Lux Aluminum Clad Series
- Available in your choice of custom or standard exterior colours
- White and sand interior options available
- Low maintenance interior and exterior
- Easy to clean interior with soap and water
- Choose from casement, awning, picture, fixed sash, rake and slider configurations
- Enjoy complete security and energy performance with Multipoint Encore®, a fully concealed, smooth operating casement locking system designed to provide exacting compression of the weather seal and window alignment in the frame
- No painting ever required



A Closer Look at the LynX Hybrid Window Series

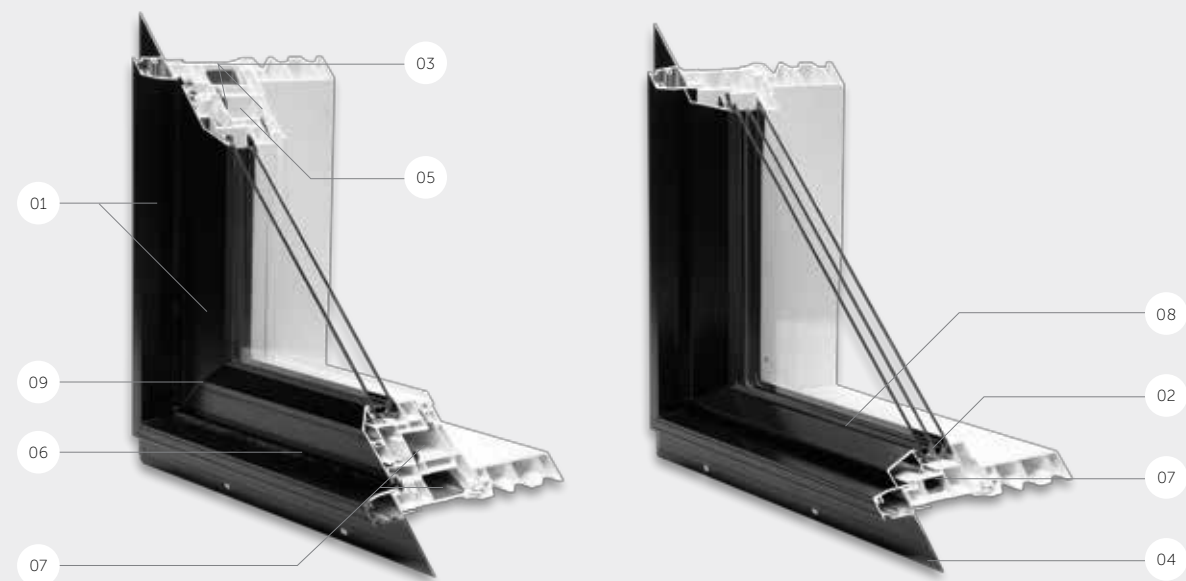

LynX Series Hybrid Casement & Awning Window Dual Glaze

LynX Series Hybrid Picture Window Triple Glaze

- 01 Extruded Aluminum Mainframe and Sash— offers greater structural capabilities to withstand the tough elements of nature and eliminates the need for painting. The aluminum is independently secured allowing the vinyl and aluminum to expand and contract without restriction.
- 02 Endur IG™ ensures outstanding thermal performance and exceptional longevity. For more information about Lux glass and glazing options, see "Glass Performance."
- 03 Heavy duty compression co-extruded seal making casements and awnings among the most energy efficient venting windows
- 04 Extruded integral nailing flange and corner gaskets, eliminating the risk of water and air infiltration between the nailing flange and the brickmould
- 05 Multi-chamber, heavy wall UV stable PVC extrusion provides thermal efficiency and colour stability. This multi-chamber design with thermal breaks not only is used to conserve heat but provide optimal stability.
- 06 High performance triple seal weather stripping—high pile is designed to let the water run out while preventing insects from entering
- 07 Steel reinforced frame and sash for added stability and security
- 08 A rubber gasket spline is a maintenance free solution to conventional caulking methods
- 09 Fusion welded corners adds strength and impedes leakage

↑ LynX Series windows feature an attractive, low maintenance aluminum clad exterior, available in a multitude of colours to suit any home exterior.

Did You Know?

LynX Hybrid sliders are now available. When considering basement windows, you can now pair Lux Windows' aluminum clad windows with our LynX Hybrid sliders for a seemingly identical match.



PVC Window Series

Both interior and exterior PVC windows are low maintenance, resisting corrosion, peeling and cracking.



A Closer Look at Lux's PVC Series

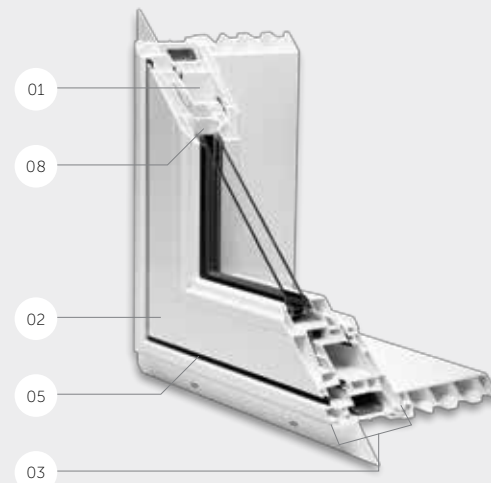

PVC Casement & Awning Window
Dual Glaze

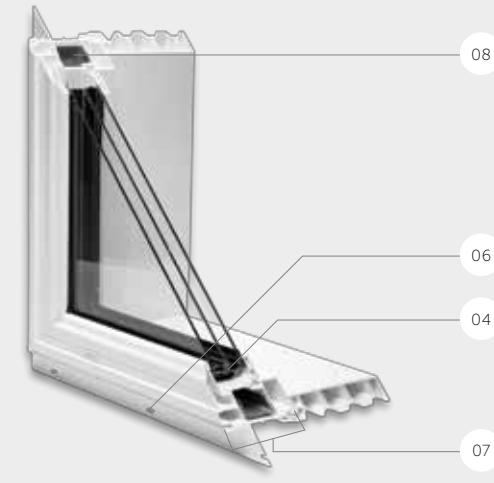

PVC Picture Window
Triple Glaze

- 01 Multi-chamber, heavy wall UV stable PVC extrusion provides thermal efficiency and colour stability. This multi-chamber design with thermal breaks is used to not only conserve heat but also provide optimal stability.
- 02 Fusion welded corners—adds strength and impedes leakage
- 03 Thick PVC walls provide exceptional impact resistance and added rigidity
- 04 Endur IG™ ensures outstanding thermal performance and exceptional longevity. For more information about Lux glass and glazing options, see "Glass Performance."
- 05 High performance triple seal weather stripping—optimal seal and performance
- 06 Extruded integral nailing flange eliminates the risk of water and air infiltration between the nailing flange and the brickmould
- 07 Accessory groove on both the interior and exterior to allow multiple options for different construction applications
- 08 Steel reinforced frame and sash for added stability and security

PVC Standard Colours

Colours may not be exactly as shown.



White

Sand

Looking for a versatile, low-maintenance and durable window solution? Then look into Lux Windows PVC Series, an ideal solution for projects where affordability is as important a consideration as energy efficiency. With a wide variety of options and configurations, PVC windows are an excellent choice for both renovation projects and new construction.

FEATURES & BENEFITS

- Available in white and sand
- Low maintenance
- Resists peeling, cracking and corrosion
- No painting ever required
- Easy to clean with soap and water
- Excellent value and affordability
- Enjoy complete security and energy performance with Multipoint Encore®, a fully concealed, smooth operating casement locking system designed to provide exacting compression of the weather seal and window alignment in the frame



Left: White PVC Window shown here with a stained casing
—
Right: Sand PVC Window shown here with a painted casing



Specialty Windows

Whether your choice is Aluminum Clad, Wood or PVC, specialty windows offer the potential for endless design possibilities.

Custom Shapes

Shaped windows are custom built to suit any plan and can add interesting detail. Combined with other window options such as our casement, awning, or sliding window styles, specialty windows offer a truly unique design component to any home.

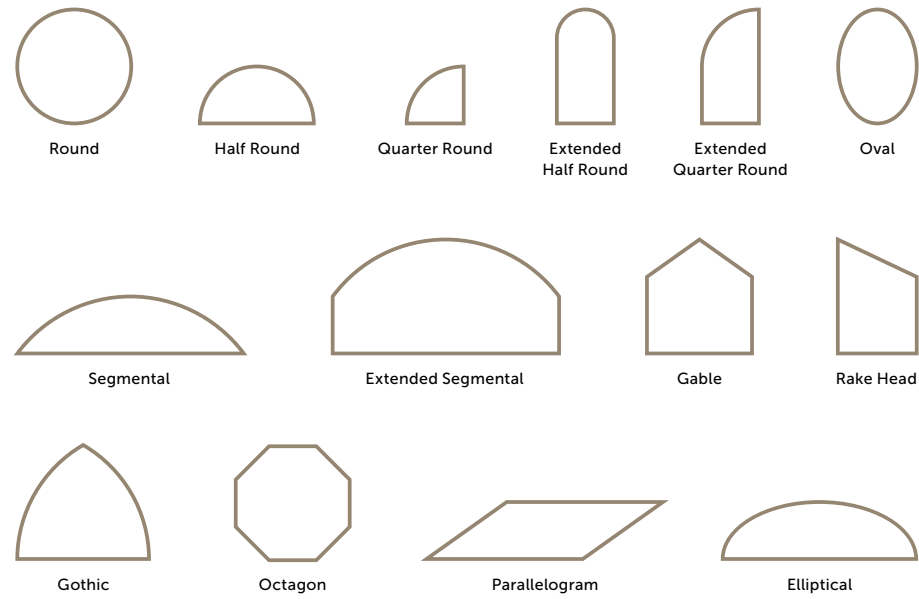

Corner Windows

Corner windows provide a seamless view from two angles allowing for maximum light and impact. Available with or without a post, this is an excellent and popular choice for contemporary architecture.

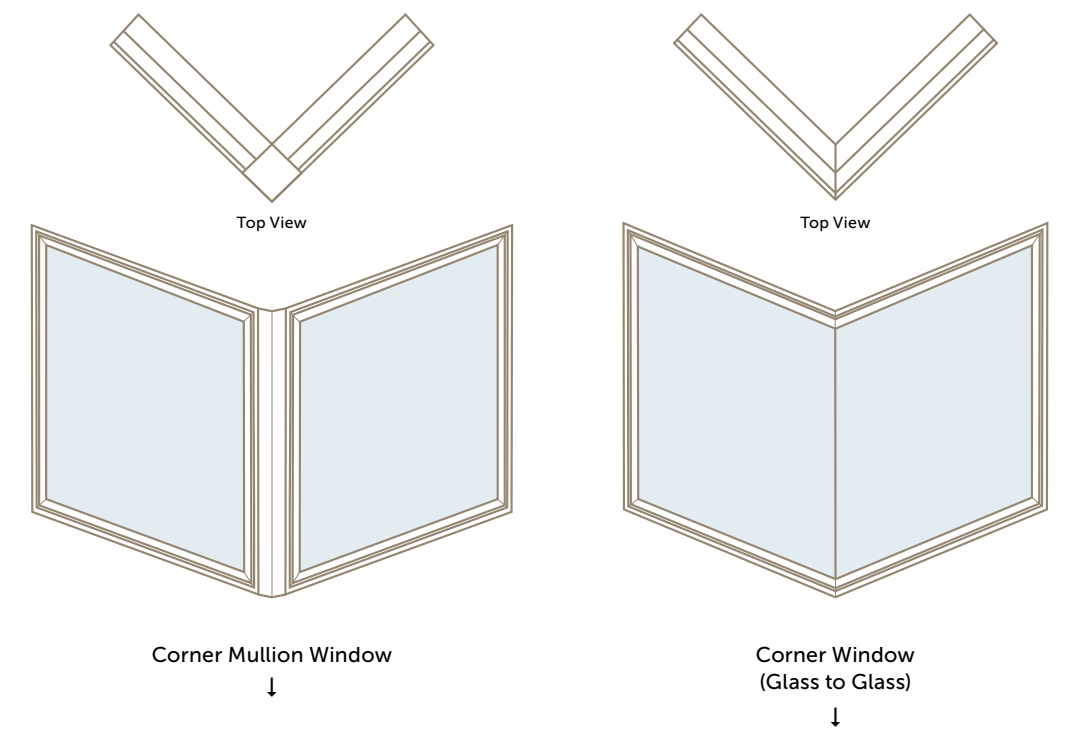

Bay & Bow Windows

Bay windows are three-sided and built at any angle desired (typically 45, 60 or 90 degrees).

Bow windows are a popular alternative to bays; four or more windows adjoin to make an arc or bow. Both bay and bow windows add living space to your home. Available in floor or bench models, bows and bays are an excellent addition to kitchens, family rooms and master suites.

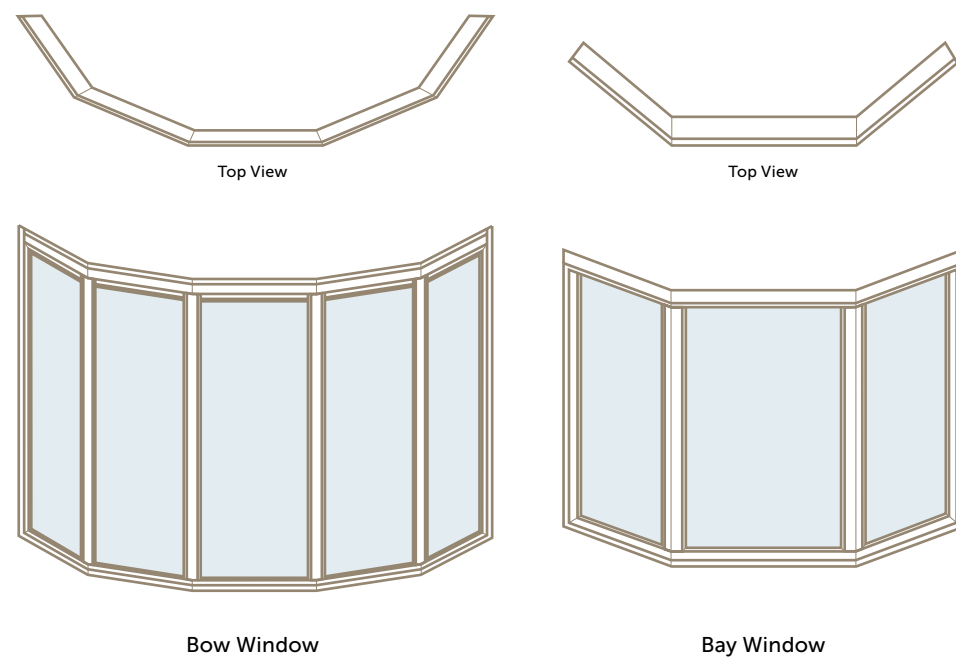



Interior Jamb



Aluminum Clad Window Series



WOOD INTERIOR
Solid Hem/Fir construction is the perfect combination of strength and extraordinary elegance. This interior can be either painted or stained to suit your home and style. Available in a variety of depths.



U-CHANNEL – DRYWALL RETURN
An open 1/2" return channel on all four sides to accommodate drywall straight into the face of the window frame for a clean and contemporary look.



Hybrid & PVC Window Series



WOOD JAMB INTERIOR
Ideal for colour matching your home's interior and can be painted or stained. Wood jamb extension is factory applied and available in a variety of depths.



PVC JAMB INTERIOR
A maintenance free vinyl interior available in a variety of depths. This jamb extension comes in white or sand and provides a clean and finished look that does not require any painting or staining.



U-CHANNEL
An open return channel on all four sides and available in either 1/2" for drywall applications, or 3/4" wide to accommodate the wood or composite extension of your choice.

Composite Jamb Interior

Introducing, a premium jamb extension, constructed of solid PVC and boasting a smooth non textured surface. Composite jamb extension is maintenance free and extremely durable. Intended to extend the interior window depth up to 13 1/2"; the most common application is for ICF Homes and concrete basements where the interior frost wall creates a broad jamb size.

INSULATED CONCRETE FORMS (ICF) →
ICF Home's are insulated building blocks with spaces that are filled with concrete; designed to increase the energy efficiency of a home. The window jambs of ICF homes are quite thick; making tradition PVC jamb extension methods unable to achieve the desired jamb depth without joints or ridges. Composite jamb extends seamlessly from the interior wall to the window frame giving a sleek finish.

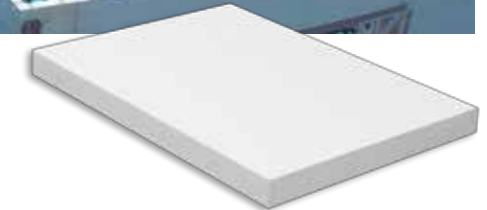



GLASS PERFORMANCE

The right glass adds livability, saves energy, saves money, and saves the environment. With Lux, every window and door can be crafted for comfort.

**Look
Inside to
Find**

ENERGY SAVINGS
WITH LOW E
WINDOWS

LOW E GLASS
TYPES

GLAZING
PERFORMANCE,
CHART &
GLOSSARY

ENDUR™
INSULATING
GLASS

PRESERV™
PROTECTIVE FILM

ENERGY STAR®
BENEFITS



Glass & Glazing Performance

Comfort, energy savings and aesthetics are all important factors to consider when choosing windows. Selecting the best glass type is equally as important as the style of window chosen for a particular location. Lux Windows and Glass Ltd. offers a variety of glazing options to suit any location or climate.

Energy Savings

ENERGY SAVING LUX LOW E GLASS

There are many Low E glass types available to suit virtually any climate; Lux Windows uses a superior product most beneficial when considering energy efficiency for Canadian weather. Low E is a unique, microscopically thin coating (not affecting clarity) containing transparent layers of metal and metal oxides. This metal coating works in tandem with an argon gas enhanced airspace, greatly reducing the sun's hot rays

from entering the home in the summer, and also traps interior climate conditions reducing energy costs of both heating and air conditioning.

Each and every Lux window and door is available with Low E glass. Low E also significantly resists damaging ultraviolet rays, protecting your curtains, furniture and flooring from fading.

Choose the Right Low E Glass for Your Home



LoE¹-180° GLASS

Trust Lux's great range of performance options to keep your home comfortable and energy efficient whatever the weather. Our Low E 180 glass effectively prevents heat transfer while allowing winter sun and light to pass through. The result? Cold air stays out, warm air stays in and natural light fills your home. The UV blocking feature also eliminates 71 per cent of harmful rays to protect what matters most.



LoE³-366° GLASS

If high performing windows are a must for your renovation or new construction project, look to Lux's Low E³ 366. A perfect blend of solar control and crystal clear visibility, this precision engineered solution eliminates heat from the sun without impacting optical clarity thanks to an additional layer of silver coating. Ultimate interior comfort and optimal energy efficiency are what makes this glass a favourite among construction professionals.



LoE²-272° GLASS

Advanced technology means the glass in your new LUX windows is smarter than you think; our Low E² 272 Glass is a perfect example. In the winter, this glass helps keep your home's interior warm and energy efficient by blocking heat loss. It works its magic during the hot summer months by preventing the sun's heat and UV rays from entering your home. Year-round comfort, year-round performance—that's 365 reasons to smile!



LoEⁱ-189° GLASS

Introducing the latest breakthrough in energy efficiency—the Low E i89. Taking an already excellent product and making it even better, our enhanced i89 glass represents a new standard in energy performance and interior comfort. The new energy-saving room-side surface coating, coupled with our Low E² and Low E³, actually reflects escaping heat back into the room and lowers U-factors. Enjoy near triple-pane performance in a double-pane unit.

The Low E Difference

Low E is a thin, invisible coating designed to reflect heat. It not only improves the energy efficiency of your home, it can reduce your monthly utility bills and the size of your carbon footprint.

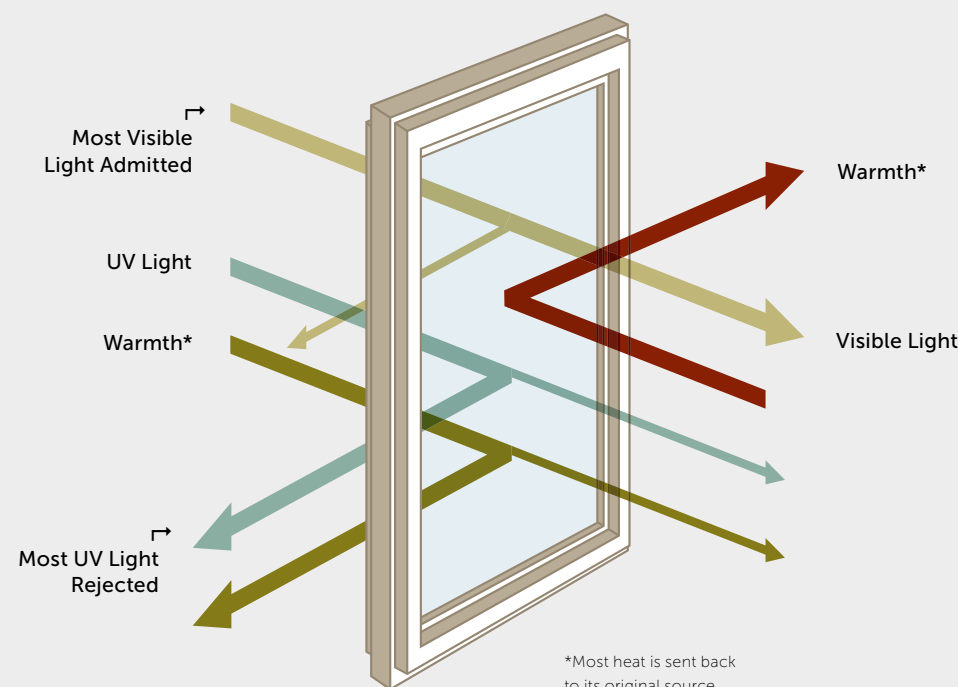

Did You Know?
25% of the heat in your home can be lost through your windows. Without energy-efficient glazing, you are essentially throwing your money out the window.



Did You Know?

Typically, 75% of the exposed surface of a window is glass and the temperature of the room-side of the glass directly affects the air temperature in the room. The better insulated the window glass the warmer your room will be.

Indoor Glass Temperature – Winter

Clear - Clear	6.66°C
LoE ² -272 #2 - Clear	13.33°C
Clear - Clear - Clear	12.22°C
LoE ² #-272 - Clear - Clear	15°C
LoE ² #-272 - Clear - LoE ¹ -180	16.66°C



Glazing Performance

ARGON GAS

As a standard, the space between the panes of glass in a Low E window are filled with argon gas—a clear, harmless gas that provides maximum insulating capabilities.

GLAZING OPTIONS

We have an unlimited number of glazing options available including dual pane, triple pane, custom obscure patterns, reflective surfaces, etc. Your sales representative can assist with glazing configurations to suit your desired requirements.



ENDUR IG – INSULATED GLASS UNITS ENGINEERED TO A HIGHER STANDARD

With its unparalleled longevity and outstanding thermal performance, Endur IG stands in a class of its own. This warm-edge stainless steel spacer improves sightline temperature and enhances resistance to condensation. The corrugated shape adds strength. Bent corners—no notches or open joints—create a continuous impermeable barrier around the entire perimeter keeping moisture out.



LUX – DOUBLE-PANE UNITS

Consist of two panes of glass with a spacer that separates them, It is required as a standard for all residential applications in Canada due to the harsh winter climate.

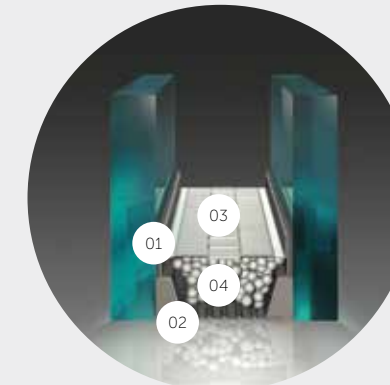

Endur IG Double-Pane Units

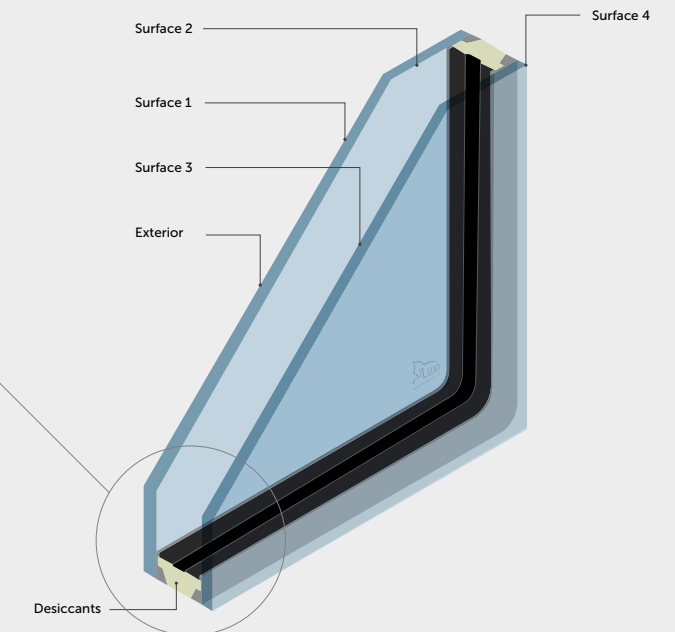

01 PRIMARY SEAL:

Polyisobutylene minimizes moisture permeation, is UV resistant and provides an outstanding argon barrier

02 SECONDARY SEAL:

Specially formulated silicone provides long-term adhesion and structural integrity, is unaffected by UV exposure and provides excellent durability when exposed to moisture

03 SPACER:

Stainless steel spacer provides maximum area for primary and secondary sealant coverage. It provides increased resistance to condensation and less stress on the seal system. No polymer content eliminates the risk of chemical fogging

04 DESICCANTS:

Beaded molecular sieve provides initial frost points below -53°C Desiccant which assures optimum moisture absorption while minimizing the effects of temperature-related pressure changes

LUX – TRIPLE-PANE UNITS

A significant enhancement from dual with three panes of glass and two spacers between. Triple-pane units offer greater performance when comparing factors such as R-value.

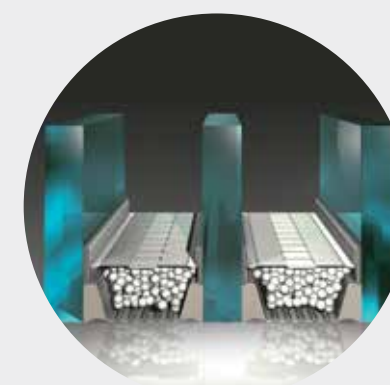

Endur IG Triple-Pane Units

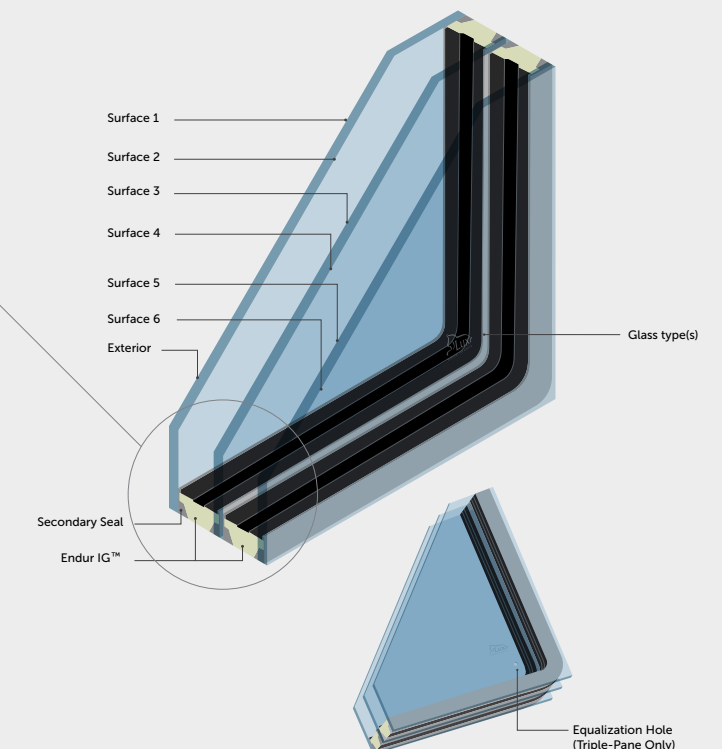



Performance Comparison

ENDUR™ IG SPACER		U-FACTOR Argon	R-VALUE Argon	SHADING COEFFICIENT	SOLAR HEAT GAIN COEFFICIENT	VISIBLE LIGHT Transmission	ULTRAVIOLET LIGHT Fading	ULTRAVIOLET LIGHT Transmission
Dual Pane	Clear - Clear	.48	2.08	.89	.78	82%	75%	58%
Dual Pane	LoE ² -272 #2 - Clear	.25	4.00	.48	.41	72%	55%	16%
Dual Pane	LoE ³ -366 #2 - LoE-i89 (#4)	.20	5.00	.31	.27	63%	41%	5%
Triple Pane	Clear - Clear - Clear	.29	3.45	.81	.71	76%	68%	49%
Triple Pane	LoE ² -272 #2 - Clear - Clear	.19	5.26	.44	.38	66%	50%	14%
Triple Pane	LoE ² -272 #2 - Clear - LoE-i180 #5	.13	7.69	.43	.37	63%	44%	8%
Triple Pane	LoE ² -272 #2 - LoE-i180 #4 - LoE-i89 #6	.11	9.09	.41	.36	62%	43%	8%
Triple Pane	LoE ³ -366 #2 - LoE-i180 #4 - LoE-i89 #6	.11	9.09	.27	.24	56%	35%	2%

Glossary

U-FACTOR

This represents the heat flow rate through a window expressed in BTU / hr / ft² / °F, using winter weather conditions of 0°F outside and 70°F inside. The smaller the number, the better the window system is at reducing heat loss.

R-VALUE

Designates window resistance to heat flow. The higher the R-Value, the more efficient the window is in reducing winter heating costs. (This number is the inverse of U-Value.)

SHADING COEFFICIENT

The measure of the total amount of heat passing through the glazing (known as the total solar heat transmittance) compared with that through a single clear glass.

The lower a window's solar heat gain coefficient or shading coefficient, the less solar heat it transmits, and the greater its shading ability.

SOLAR HEAT GAIN COEFFICIENT – (SHGC)

The amount of solar radiation that enters a building as heat. The lower the number, the better the glazing is at preventing solar heat gain.

FADING TRANSMISSION

The portion of energy transmitted in a spectral region from 300 to 700 nanometers. This region includes all of the ultraviolet energy and most of the visible spectrum, and will give the best representation of relative fading rates. The lower the number, the better the glass is for reducing fading potential of carpets and interior furnishings.



Preserve™ peels off easily, revealing gleaming new windows below.

Preserve Your Investment



Lux protects your investment with Preserve™ protective film, ensuring you can enjoy the immediate benefits of perfectly clean and flawless glass after your new construction or renovation is complete.

FEATURES & BENEFITS

- A robust coating offering protection against scratches, paint, mud and construction debris
- Factory applied to both the interior and exterior glass
- Easy, one-piece removal with no residual glue or adhesive
- Quickly reveals totally spotless, unblemished glass

ENERGY STAR® Certified Products by Lux



As the mark of high-efficiency products in Canada, the familiar ENERGY STAR® symbol makes it easy to identify the best energy performers on the market.

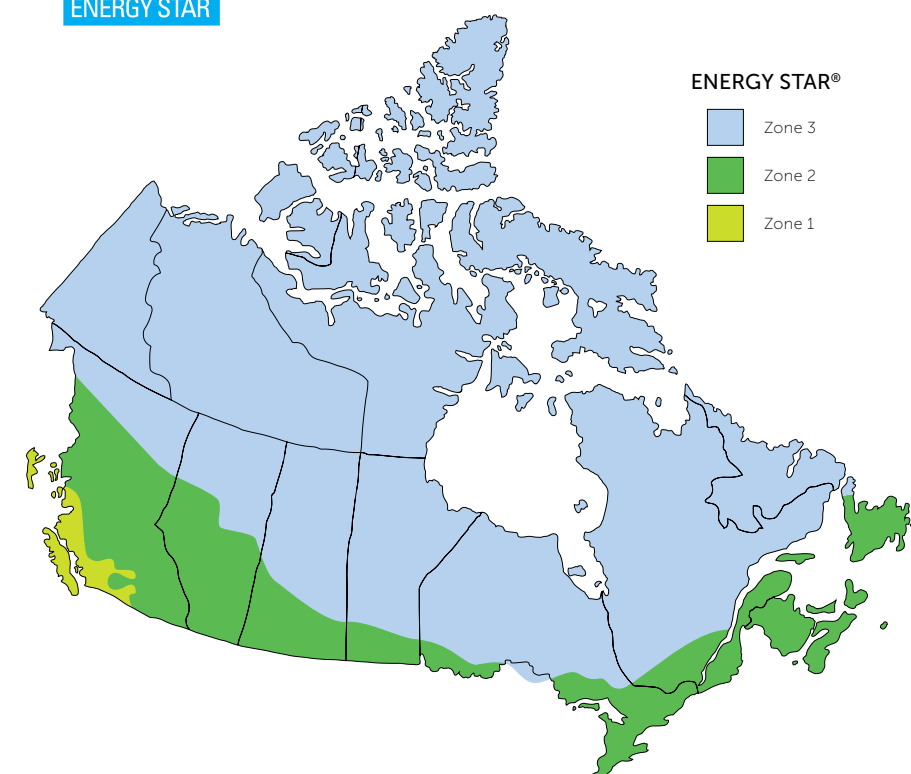

ENERGY STAR certified products meet strict technical specifications for energy performance—tested and certified. They save energy without compromising performance in any way. Typically, an ENERGY STAR certified product is in the top 15 to 30 percent of its class for energy performance. Saving energy saves you money and reduces your impact on the environment.

Choosing ENERGY STAR qualified products by Lux means choosing to:

SAVE ENERGY

ENERGY STAR qualified products use significantly less energy. Typically, they use 20 to 30 percent less than regular models.

SAVE MONEY

Using less energy means you'll save on your utility bills.

PROTECT THE ENVIRONMENT

Using less energy reduces greenhouse gas (GHG) emissions. ENERGY STAR qualified products are also backed by a tough performance and testing regime.

TESTED & CERTIFIED

The ENERGY STAR symbol means a product has been tested and certified by a government-approved agency.

QUALITY PERFORMANCE

ENERGY STAR qualified products have the same features and performance as other quality products.



FINISHING TOUCHES

Your home, your style.
Enhance your new windows with your choice of custom finishings and design features, fashionable hardware and modern glass options.

**Look
Inside to
Find**

EXTERIOR
WINDOW
COLOURS

EXTERIOR
WOOD GRAIN
OPTIONS

BRICKMOULDS

SIMULATED
DIVIDED LITES,
GRILLS &
HARDWARE



Aluminum Clad, LynX Hybrid & Batten Brickmould Exterior Window Colours

Customize the exterior of your aluminum clad, LynX Hybrid or batten brickmould windows with a colour perfectly suited to your home's unique palette. Choose from the eight Lux signature colour options below and instantly add curb appeal to any new home construction or renovation.



Colours may not be exactly as shown and are subject to change without notice. Please contact a Lux consultant for details.

Aluminum Clad, LynX Hybrid & Batten Brickmould Exterior Wood Grain Options

Offering all of the warmth and style of real wood, but with the durability, weather resistance and low maintenance qualities of aluminum cladding, Lux's incredibly realistic wood grain finish offers homeowners the option to select a truly exceptional finish for their window exterior. Constructed of aluminum and suitable for all aluminum clad, LynX Hybrid and batten brickmould windows, but with the character of authentic wood, Lux's wood grain finishes add a distinctly natural feel to any exterior.

THE CHARACTER & STYLE OF REAL WOOD, BUT WITHOUT MAINTENANCE HEADACHES



Colours may not be exactly as shown and are subject to change without notice. Please contact a Lux consultant for details.

Brickmoulds

Exterior Fixtures



ALUMINUM BRICKMOULD
Available in 5/8", 2" and 3 1/2".
This option comes standard with an integral nailing and is versatile for both renovation and new construction applications. Shown here in the 2" option, this brickmould is a great way to increase curb appeal.



BUILD UP & CLAD
Build up and Clad is an option when replacing windows to provide a prefinished exterior in a wide variety of colours and widths. This technique is low maintenance and extends past the frame of the new window.



PVC RENOVATION BRICKMOULD SHOWN HERE WITH 1" SUB-SILL
PVC Renovation Brickmould is factory applied and specifically designed for replacing windows. The removable cap around the perimeter conceals the mounting screws making the replacement seem virtually invisible. The cap

is contoured for added aesthetic appeal and gives a clean and fresh finish to your renovation. Available in 1 1/2", 1 3/4" and 2" sizes.

1" Sub-Sill features the same heritage detail found in a wood moulding but with the longevity and durability of vinyl, making it maintenance-free. Combined with our Renovation Brickmould, it further compliments our PVC Window Series and makes replacing older wood windows with a sub-sill seamless.



PVC Brickmoulds

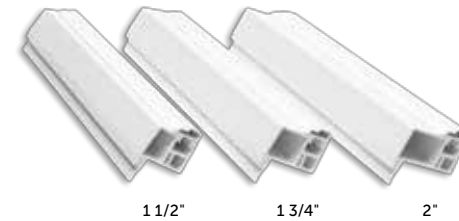

Aluminum Brickmoulds

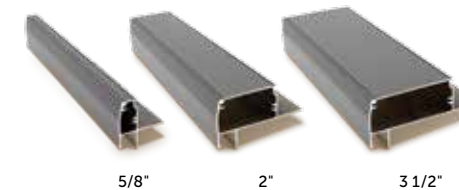

Wood Brickmoulds

Custom designs also available.

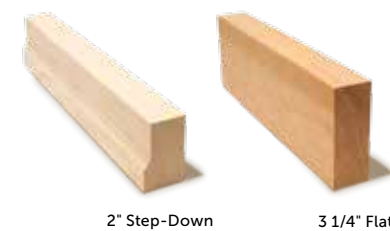

Wood Exterior Windows

Both window interiors and exteriors can be stained or painted to create the design effect best suited to your home. A variety of brickmoulds, from contemporary to traditional, are available to match any architectural design. We use solid clear wood with no finger joints to provide the flexibility you need to paint or stain the exterior, customizing to suit your personal preferences.



Batten Brickmould Windows

Innovated and offered exclusively by Lux, the batten brickmould window is a high performance, high style option created with the needs of homeowners, builders and renovators in mind. Stylish, durable and conveniently installed in one easy step, it offers an attractive, leak-free solution that outlasts and outperforms traditional batten windows.

FEATURES & BENEFITS

- Can be customized for a variety of sizes
- Outstanding weather resistance and durability
- Installed as one complete unit, requires no caulking
- Optional natural-looking wood finish and custom colour matching
- A visually stunning 3 1/2" aluminum extruded brickmould
- Addresses flashing details typically required by building code
- 3 1/2" finished face with an integral nailing fin

No window on the market today is more advanced than the award-winning Lux batten brickmould window.



SAM Awards Winner, Best Innovative Product

Lux's Exclusive Batten Brickmould Windows

vs

The Painted Smart Board Batten Method



- 01 Attached batten brickmould
- 02 No caulking required
- 03 Integral nailing fin
- 04 Corners protected with multiple gaskets
- 05 All components powdercoated to ensure colour match



- 01 Smart board that requires endless maintenance and paint
- 02 Multiple flashing required
- 03 Gap between window and trim to allow water to enter and damage the envelope seal during freeze/thaw cycles



Simulated Divided Lites (SDL) & Grill Designs

SDL and grill bars are often added to customize a window and match the architectural style of the home. When applied, SDL's give the traditional true divided lite appearance, while grills offer additional decor options to complement your choice of window style.

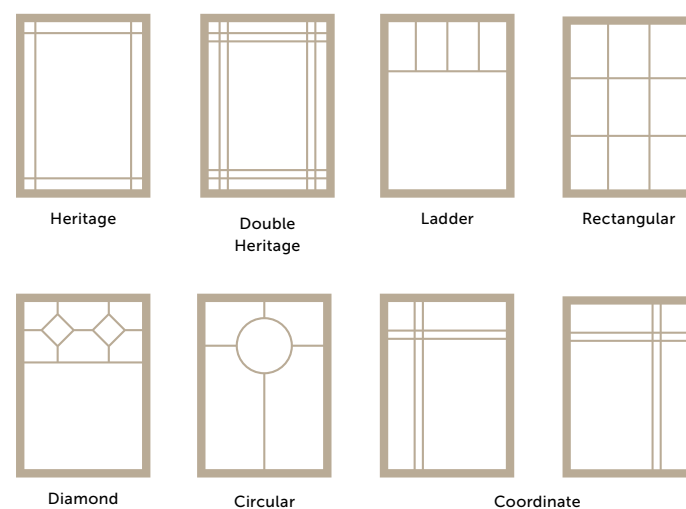

Curved top windows are enhanced with custom designed simulated divided lites that can be built in virtually any configuration. In addition, packed mullions add dramatic style to the window.



5/8" Grills



3/8" Grills



SIMULATED DIVIDED LITES SERIES

Available for all window types in your choice of custom or standard colours.

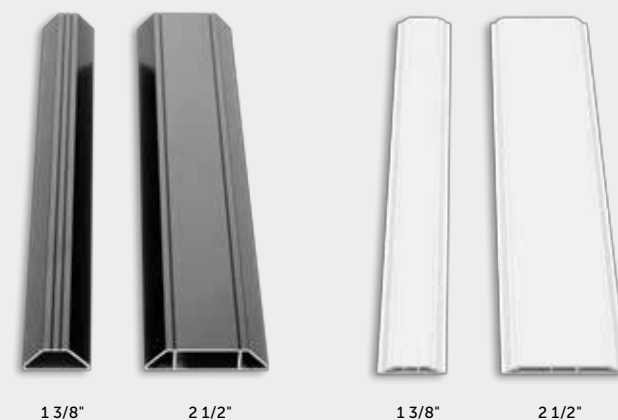

Shown here in aluminum and available in your choice of custom or standard aluminum exterior colours. Can be paired with a wood or PVC interior.

Shown here in PVC and available in both Sand and White.





Hardware

For over 50 years, Truth Hardware has been recognized as the industry leader in the design and manufacture of quality operating hardware. This hardware meets, or exceeds the maximum performance requirements that are sought in today's market of larger, more versatile casement and awning windows. Truth Hardware has long been recognized for its vast array of quality finishes and its ability to provide the most attractive, easiest operating and highest performing window hardware.

Lux windows include Truth Hardware operators with standard collapsible handles to avoid interference with blinds.



White



Sand



Brushed Chrome



Coppertone



Bronze



Black

Colours may not be exactly as shown and are subject to change without notice. Please contact a Lux consultant for details.

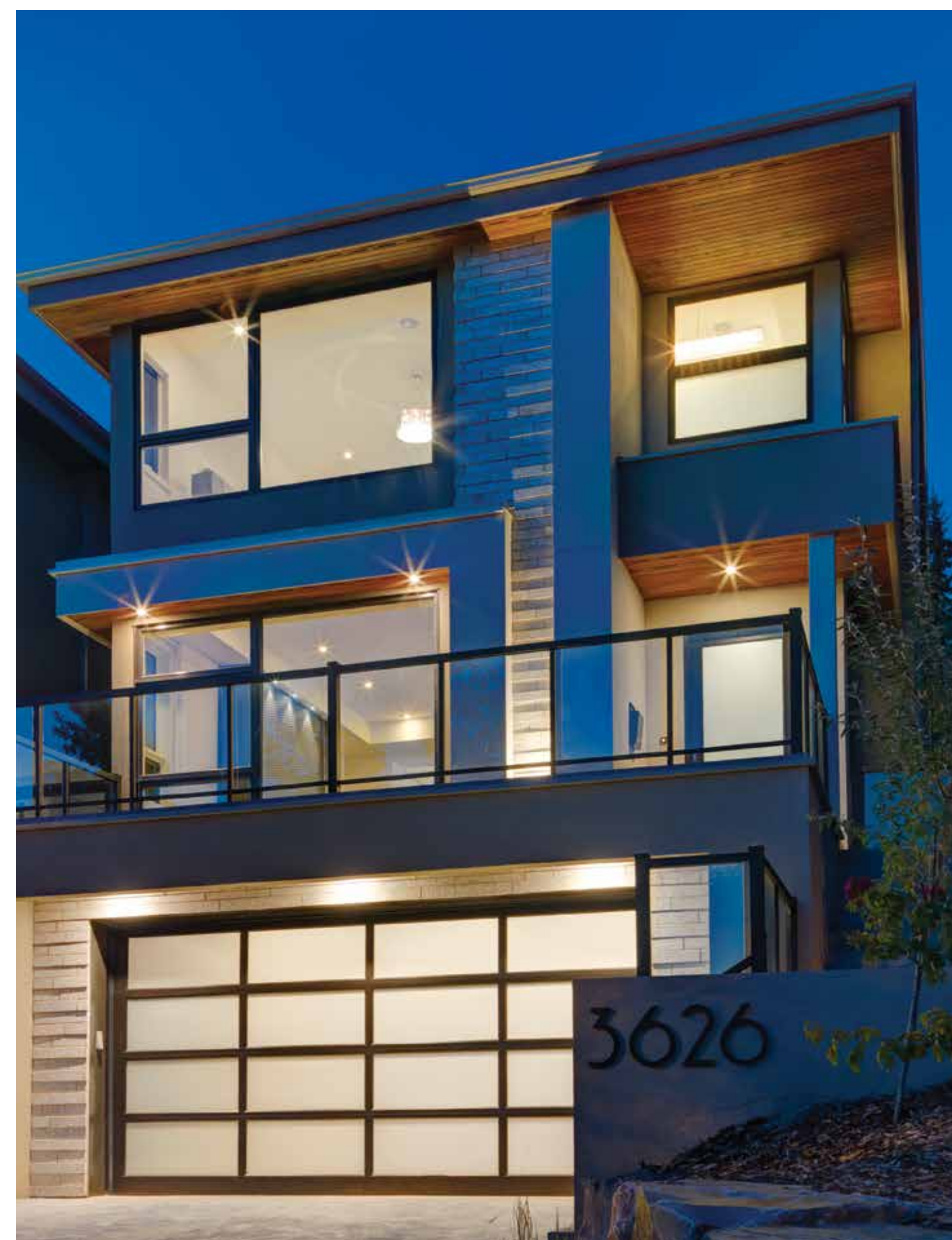



DOORS

Lux's selection of door styles, materials and hardware options suit any architectural style and are guaranteed to help you make a truly memorable entrance.

**Look
Inside to
Find**

- ALUMINUM EXTERIOR DOORS
- ALUMINUM CLAD PATIO DOORS
- TESORO FOLDING DOOR SYSTEM
- FIBERGLASS DOORS
- DOOR OPTIONS
- PVC SLIDING PATIO DOORS

Aluminum Exterior Doors

(FIR CLAD)

Aluminum exterior doors provide a low maintenance exterior with the elegance of a wood interior. What makes these doors unique is their engineered LVL laminated styles and rails, resulting in maximum durability and strength. Exteriors are available in all Lux standard colours and in either outswing or inswing.

Indoor View



Outdoor View

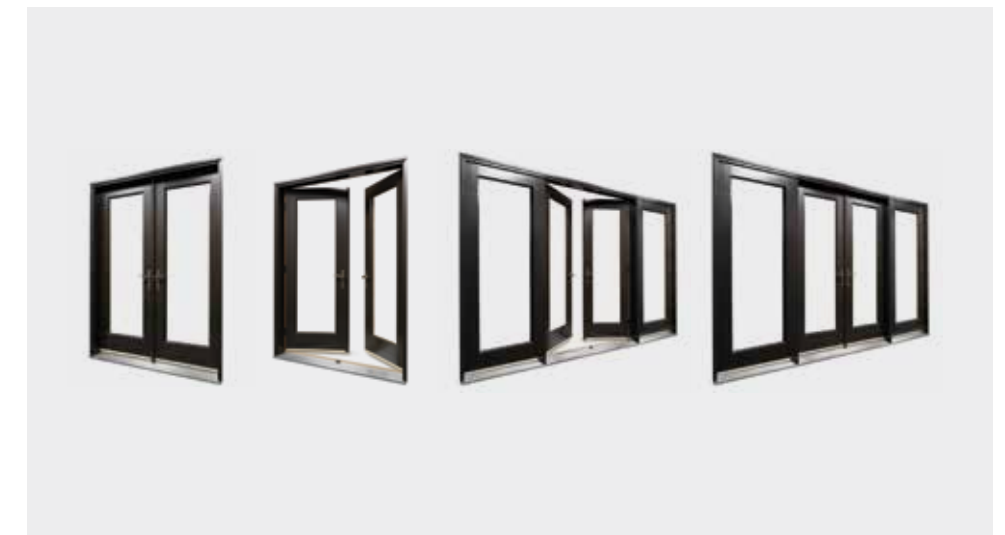

← Opposite:
Aluminum exterior doors paired with SDLs
—
Top: Can be paired with aluminum clad window series in a multitude of combinations
—
Bottom: Stained interior for added warmth



Aluminum Clad Patio Doors

Lux patio doors feature an aluminum clad exterior with a Laminated Veneer Lineal (LVL) Clear Hem/Fir Wood interior. With a clean, modern design, each door has a large glass surface area designed to draw welcoming daylight into the room.

Brass tandem rollers allow for easy functionality and sliding integral screens are available for added convenience. The bi-parting patio doors allow the centre panels to open to the outside, creating a striking entranceway. All of our aluminum clad patio doors include a multipoint locking system for added security.

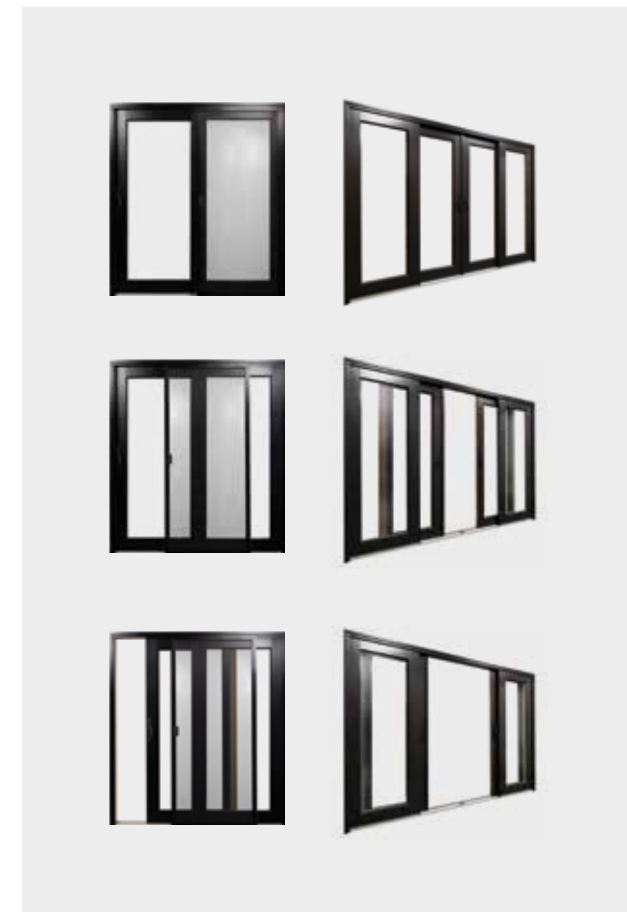



Outdoor View



TESORO Lets the Outdoors In



FIG. 01



FIG. 02



FIG. 03



FIG. 04



FIG. 05

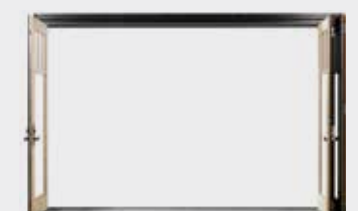

FIG. 06

TESORO Folding Door System

This unique folding door system, crafted exclusively by Lux, easily opens and slides to the side, literally opening your living area to the scenery beyond. With a clean and sophisticated design sensibility, TESORO's expansive glass surfaces are designed to draw welcoming daylight and scenic views indoors.

TESORO is built for year-round comfort and enjoyment, with state-of-the-art hardware that allows even the largest door configurations to glide from open to closed quietly and with ease.

FEATURES & BENEFITS

- The choice of homeowners, architects and designers inspired to add lasting beauty and value to their residential and commercial projects
- Expand your home or commercial space by opening walls to create transitional indoor or outdoor rooms and gathering places
- Designed, manufactured and double-weatherstripped to withstand Canada's climate
- More than 25 possible configurations, with options for glazing to personalize your door system for your space
- Suited to residential homes and to commercial environments, adaptable to either new construction or renovations
- Features engineered LVL laminated styles and rails, resulting in maximum durability and strength
- A multi-point locking system provides added security with the turn of a handle
- Extruded aluminum exterior in a selection of colours ensures a low maintenance exterior with the elegance and versatility of a wood interior
- Covered by Lux's industry-leading warranty to ensure quality, ease of operation and enjoyment for years to come



Indoor View

Fiberglass Doors

Step into luxury each and every time you come home to a Lux fiberglass door, perfectly customized to reflect your personal style.

A fiberglass door is an excellent option for any exterior door. Stylish and dent resistant, they feature top-of-the-line insulating characteristics and are available in smooth or textured finishes.

Fiberglass doors with a smooth skin have a clean, simple style and can easily be painted to coordinate with the rest of the home. Textured fiberglass offers greater flexibility and can be painted, stained or enhanced with panels to give the appearance of real wood while providing superior insulating values, lower maintenance and better durability.

The New Lux Revolutionary Inswing Door Sill



Choose the Lux Fiberglass Door Series that best suits your home and style

- Glacier Exterior Door Series
- Woodland Exterior Door Series
- French/Terrace Doors
- Garden Doors



Top: Craftsman Door and Sidelites with Spring Glass 4 Block Dentil Shelf

Bottom Left: Masonite Flagstaff Series

Bottom Right: Masonite Full Lite and Sidelites with Kordella Glass

A Variety of Inserts & Door Panels

This is just a few of the many inserts and panels available when selecting you Lux door.

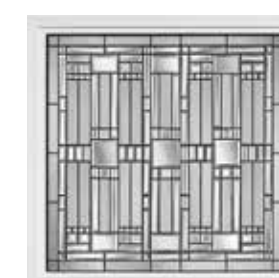

Naples Accent Window

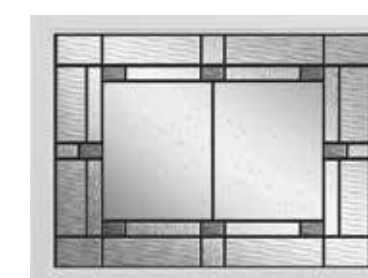

New Marco Craftsman Lite

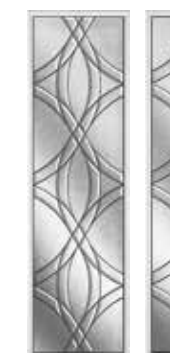

New Chelsea Full Lite & Side Lite



New Optimus 3/4 Lite

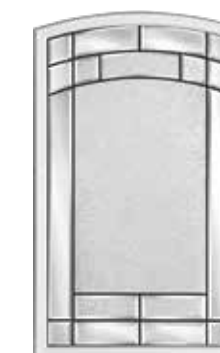

Element Camber-Top



New Open & Beaded 3 Lite



New Open & Beaded Narrow Lite



FIBERGLASS DOORS

Glacier Series (Smooth Skin Doors)

Smooth skin doors can infuse any home with a traditional, elegant style. With a smooth finished surface and solid pigment skin, their sophisticated yet understated design creates seamless transitions.

3/4 lite open and beaded with masonite aria glass.



FIBERGLASS DOORS

French/Terrace Doors

The traditional, classic beauty of our French doors creates an open feeling by seamlessly connecting the outside world with interior living space. With no centre mullion, the glass panes provide unobstructed views while expressing a simple yet polished elegance. Available in inswing and outswing applications.



DOORS



Woodland Series (Textured Skin Doors)

(Textured Skin Doors)

Enhanced with a wood grain finish, our textured doors feature the beauty of a real wood door, but at a fraction of the price. Equally important, they resist warping, splitting and cracking in cold weather—a luxury not always afforded by traditional wood doors.

Shown in a 2 panel chamber plank.



Garden Doors

Garden doors offer a balanced appearance from the outside, with one or more doors opening as the passageway, while the others act as a vent. The beauty of these doors is that the venting door comes with a screen allowing increased airflow into your home while keeping dust and debris from entering.



Door Options

Door Panels

Lux fiberglass doors are available in a variety of widths and heights, and are designed to complement any entranceway. Handcrafted and built to last, they repel moisture and will not warp over time. For added peace-of-mind, each door features enhanced strength and security features.

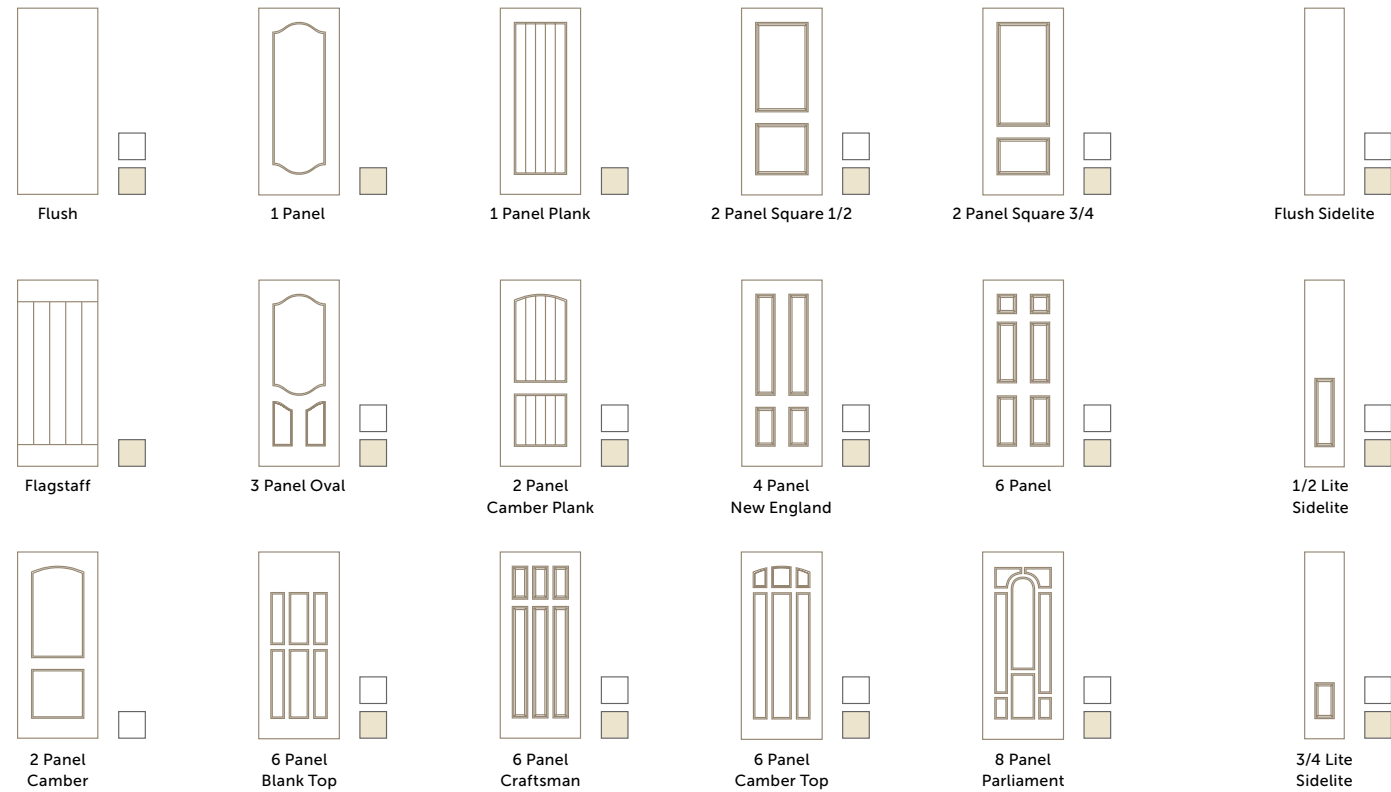

DOOR PANEL & FLUSH GLAZING OPTIONS

- GLACIER**
(smooth skin white fiberglass doors)
- WOODLAND**
(textured fiberglass doors)

Flush Glazing

Lux's innovative flush glazing system gives each door a polished, uninterrupted visual appeal.

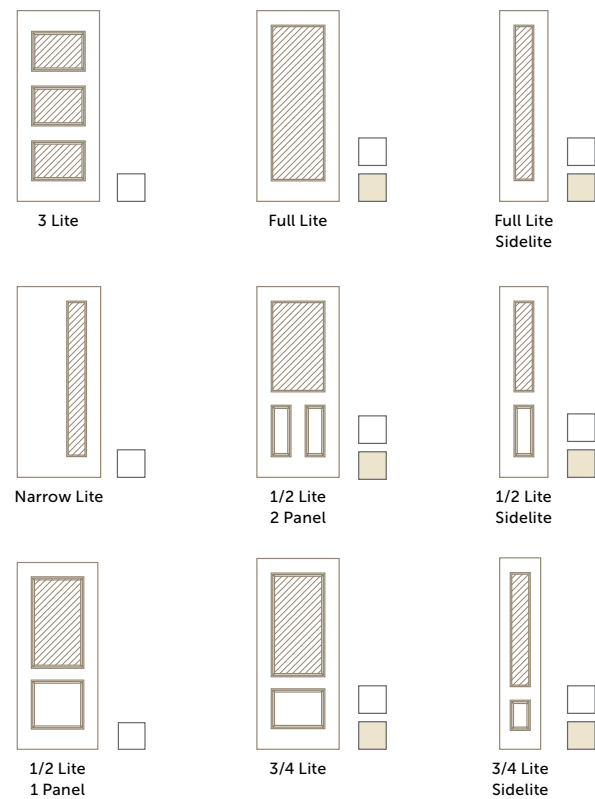

Traditional Insert
Over time, traditional inserts may discolour or begin to break down. However, Lux doors with open and beaded inserts are both water and weather resistant, and therefore, retain their beauty for years to come.



Open & Beaded Insert (Flush Glazing)



Decorative Inserts & Panels

Create instant elegance by adding a decorative glass insert to any door, transom or sidelite in your home. Lux offers a diverse collection of inserts, plus a variety of panel options designed to coordinate with your selection.

Sidelites & Transoms

Add sophistication to your home without compromising security or privacy with Lux's custom door options. Simply select your choice of sidelights, venting sidelites or transoms to infuse each entryway with architectural style while filling your home with welcoming light.

Multipoint Hardware

Multipoint hardware is designed to lock at several points throughout the height of the door making the lock side of the door as secure as the hinge side and provides an exacting seal around the perimeter of the door. Lux's hardware selections will add character and enduring value to every door in your home. Made of solid brass, each handle can be personalized with your choice of finishings to complement your personal style. All hardware is specially crafted to resist wear, and like the door itself, will last a lifetime.

HARDWARE STYLE OPTIONS

Choose the hardware style that best suits your personal taste:

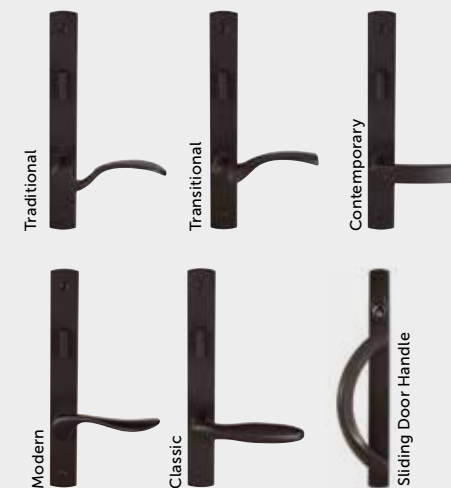

HARDWARE COLOUR OPTIONS

Customize your hardware with your choice of 9 colours:



PVC Sliding Patio Doors

Sliding patio doors provide the added benefit of a rolling screen and no swinging panel to take up valuable living space inside your home. With no obstruction to impede your view, the large glass area can be compared to a window with limited sightlines. PVC sliding patio doors are also available in bi-parting 4-wide and 3-wide sidelite combinations with multiple transom options.

Did You Know?

PVC sliding patio doors are available in multiple combinations.



This simple, unobstructed design allows maximum amounts of natural light into the room. ↗



The exterior sliding screen allows fresh air inside while keeping bugs and debris outside. ↗





RENOVATIONS & PROJECTS

Rediscover the view.
Lux is proud to offer
the expert guidance
and peace-of-mind
warranties needed to
make your project a
"happily ever after."

**Look
Inside to
Find**

RENOVATION
PROCESS

CUSTOMER
STORIES

COMMERCIAL
PROJECTS



RENOVATE WITH LUX

Lux Windows understands that the prospect of a renovation can seem challenging. We're here to help, and will work closely with you to find the right windows and doors for your needs, taste and budget—ensuring your renovation experience is both easy and enjoyable.

The end result? A renovation that not only looks great, but is completed with structural integrity and durability for years to come.

Renovation Process

At Lux, we specialize in window and door renovations, allowing you to rest assured that we will take you through the process quickly and efficiently.

From the initial phone call through to the actual installation, our goal is to provide an exceptional product, competitive prices, and unparalleled service. Let's get started!

STEP-BY-STEP PROCESS

1. Initial customer inquiry
2. In-home consultation
3. Assessment of all windows and doors being replaced
4. Friendly advice on products available to suit any home and budget
5. Estimate is provided

THE ORDER

1. Initial 25% deposit required upon approval of order
2. Lux will take measurements of each door and window being replaced
3. Products are manufactured locally according to specifications

THE INSTALLATION

1. Convenient installation date and time is scheduled with homeowner
 2. Care and attention is given to performing all work quickly and efficiently
 3. Homeowner is consulted if any hidden damage is found
 4. Old windows and doors are removed from site
 5. Work areas are swept and debris removed
-



Why Renovate with Lux Windows?



CRAFTED FOR ALBERTA'S CLIMATE
Our products are designed with care and built to the highest energy efficiency standards, right from our state-of-the-art facility here in Alberta.



PRODUCT DIVERSITY
Lux Windows offers the most complete line of windows and doors, customized to suit your home, style and budget. From classic to modern, you are sure to find the right products for you.



FINANCING
We are pleased to offer alternative payment methods to assist with your home renovation. This allows you to outfit your home to be more energy efficient, saving you money down the road.



BUILT BY NEIGHBOURS, FOR NEIGHBOURS
Lux is a family-owned and operated business, and we are proud to fuel the local economy by manufacturing right here in Alberta. Our owners and employees live in the same communities as our customers and give back to those communities through various donations and sponsorships programs.



ENVIRONMENTAL RESPONSIBILITY & LEADERSHIP
Because we live and work in Alberta, we place a high value on keeping Alberta's air and water clean. We are committed to minimizing our environmental impact through active recycling programs, and continuous upgrades to our showroom and manufacturing facility to decrease unnecessary power consumption.



SAFETY OF OUR EMPLOYEES
Lux is Workers' Compensation Board certified and dedicated to the health and safety of our employees. We provide proactive workplace safety as an accredited Certificate of Recognition partner—a program that recognizes companies with an effective health and safety management system.



Warranty

Lux offers an industry-leading 25 year warranty and a 5 year warranty on installation-related labour and warranty materials.



Getting Ready

As you begin thinking about replacing your windows and doors, ask yourself these questions:

- What do you like about the windows and doors that are currently in your home?
- What problems are you experiencing? Aesthetics, cold drafts, poor ventilation, inoperability?
- Are there any fixed windows you would like to replace with venting windows to allow for natural ventilation?
- Would you like your windows to be low maintenance?
- Is it important to minimize outdoor noise?
- Is energy efficiency a primary goal for your renovation project?
- Do you want to take advantage of existing energy efficiency incentive programs?

Based on your unique needs, we're here to make recommendations that will result in windows and doors you love for years to come.

Professional Installation

Even the highest quality windows and doors will underperform if they are installed incorrectly; this can lead to exposure to the elements, thermal heat loss, or issues with structural integrity.

That's why Lux installers are masters at their craft. In fact, our highly skilled and experienced installers are well-versed in home construction principles and techniques well beyond the installation of windows and doors. They will ensure that all rough openings are free of damage, and make the necessary adjustments to the frame before installing the product.

Installations completed with the detailed work of a trained professional who cares to do it right the first time—that's the Lux way. In our minds, it's the only way.

RenoSHIELD

Lux's RenoSHIELD process offers maximum protection from moisture encroachment. Because water can accumulate in window openings causing structural damage, Lux exceeds industry standard by applying an advanced waterproofing membrane that provides seamless protection at the sill corners and assists positive water drainage to the exterior.



Frequently Asked Questions

HOW MUCH WILL MY WINDOW & DOOR RENOVATION COST?

Many variables affect the cost of replacing your windows and doors, including product type, scope of work involved, and design changes that will impact the size and shape of the opening. Our very knowledgeable and experienced renovation consultants will be able to provide you with recommendations and a free quote to ensure the ideal solution for your project.

CAN I RENOVATE MY WINDOWS & DOORS IN THE WINTER?

Certainly. You can enjoy the immediate benefits of improving your home's appearance any time of the year. If you are experiencing heat loss through your windows and doors, don't wait to increase your home's comfort level and improve its thermal performance.

HOW LONG WILL MY RENOVATION TAKE?

Our qualified installers complete most renovations within one to three days, on average, depending on the complexity of your renovation and how many windows and doors are being installed.

OTHER QUESTIONS ABOUT THE WINDOW AND DOOR RENOVATION PROCESS?

No problem! Simply call your local Lux showroom, and one of our friendly renovation consultants will be happy to help make your renovation a "happily ever after."

Before & After

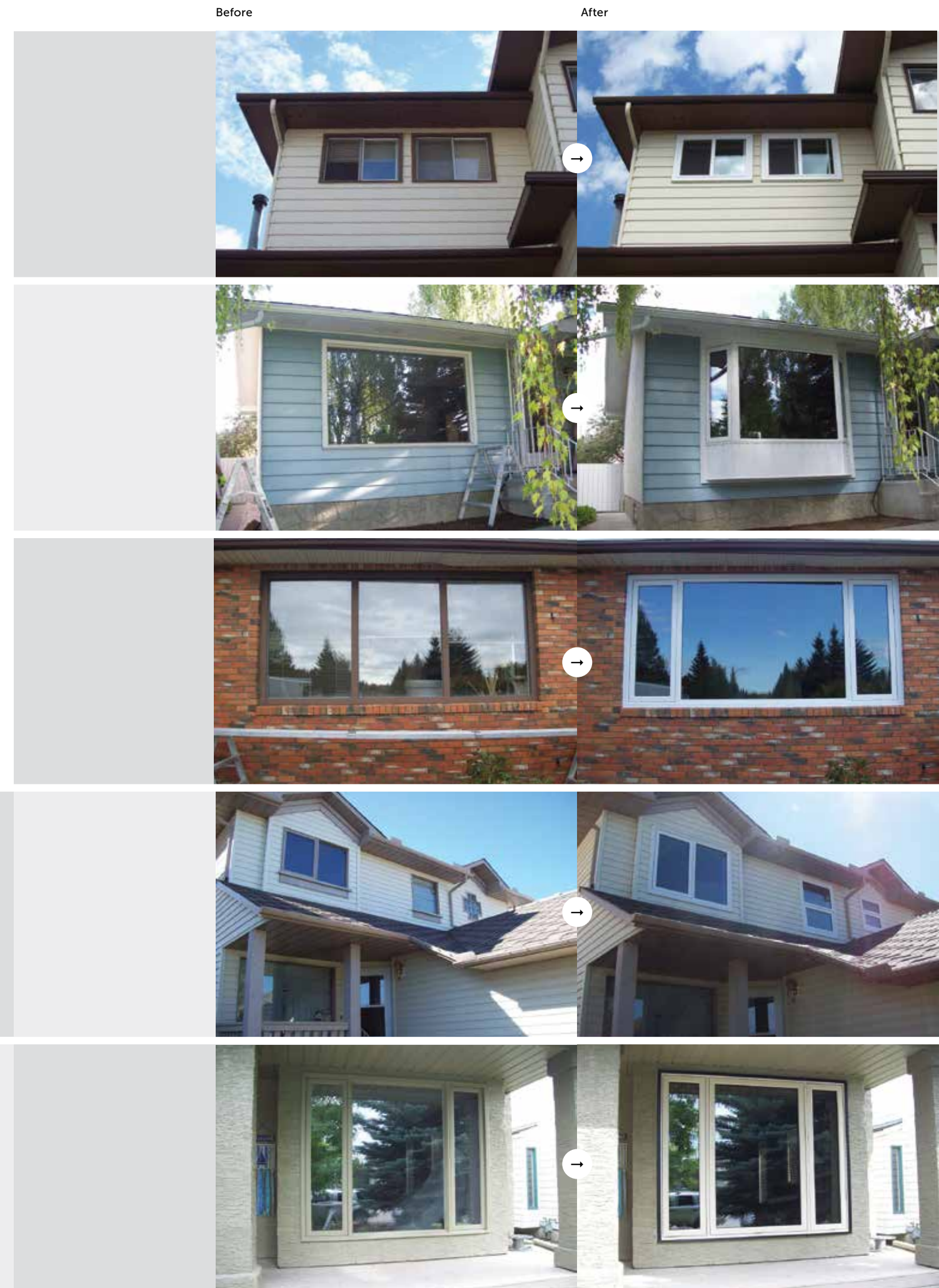



C. MCCLOY

The whole team at Lux, from the retail side to the installation coordinators, and especially the installers themselves, have completely blown me away—they went above and beyond! I'll be doing more projects on my home in the future and there is absolutely no other company I'll be contacting. Thank you to the whole team at Lux for everything.

T.H. CHESTER

Once again, many thanks for your excellent service and expertise. We are completely delighted with our new door and windows.

J. JACOBS

I would like to thank you for a job well done and must compliment the installers who came to my home to do the work. They were a pleasure to have in my home; they cleaned-up after themselves and were very polite. Again, thank you for a job well done!

THE INKSTERS

Thank you very much for the great service your helpful staff provided. Unfortunately, we had some initial issues with our window, but they were dealt with promptly and correctly. As they say, it is when things do not go as planned that the men distinguish themselves from the boys. Well, Lux Windows certainly came through for us! We would definitely choose your product and services again.

M. FRASER

My windows were just installed and they look great! They carefully removed my old windows and then vacuumed all of the dust and debris. They even shoveled my sidewalk for me! I would gladly recommend Lux Windows to your future customers.

B. SINCLAIR

Thank you so much. We are thrilled with our new windows and wanted you to know that your installers did an excellent job. We will certainly be calling to order more when we're ready to move on to the next stage of our project.

THE GOWLINGS

I thought I'd take a moment to share how happy we are with your entire team and your product. Some highlights include the sales team, who were prompt and offered solid value pricing; production, who adapted to changed dates to deliver as promised; as well as construction and delivery, who were courteous and helpful. I have toured the Lux plant and your team obviously cares and builds a fantastic window—quite simply, pure quality and beauty. We could not be happier, and everyone who sees our new windows asks where such beautiful windows come from. Please pass on my thanks to everyone at Lux.

F. SCHNEIDERSMANN

We would like to thank you for your efforts and customer focus, and for the tremendous service that Lux has delivered. Without your outstanding team, the job would not have been completed with the quality, professionalism and timeliness we experienced in this one day. To us, this is a true reflection of your team's respect for Lux products and the customer. Please also express our appreciation to all those behind the scenes in the office and factory. All of these folks are true craftsmen who take great pride in their work. They exceeded our expectations and are certainly outstanding ambassadors of Lux on the front line.



Customer Stories

Our greatest compliment is the trust our customers place in us to exceed expectations. Craftsmanship and service are the hallmarks of our reputation and they are what motivate us to be the best—not just by our standards, but also by our customers'.

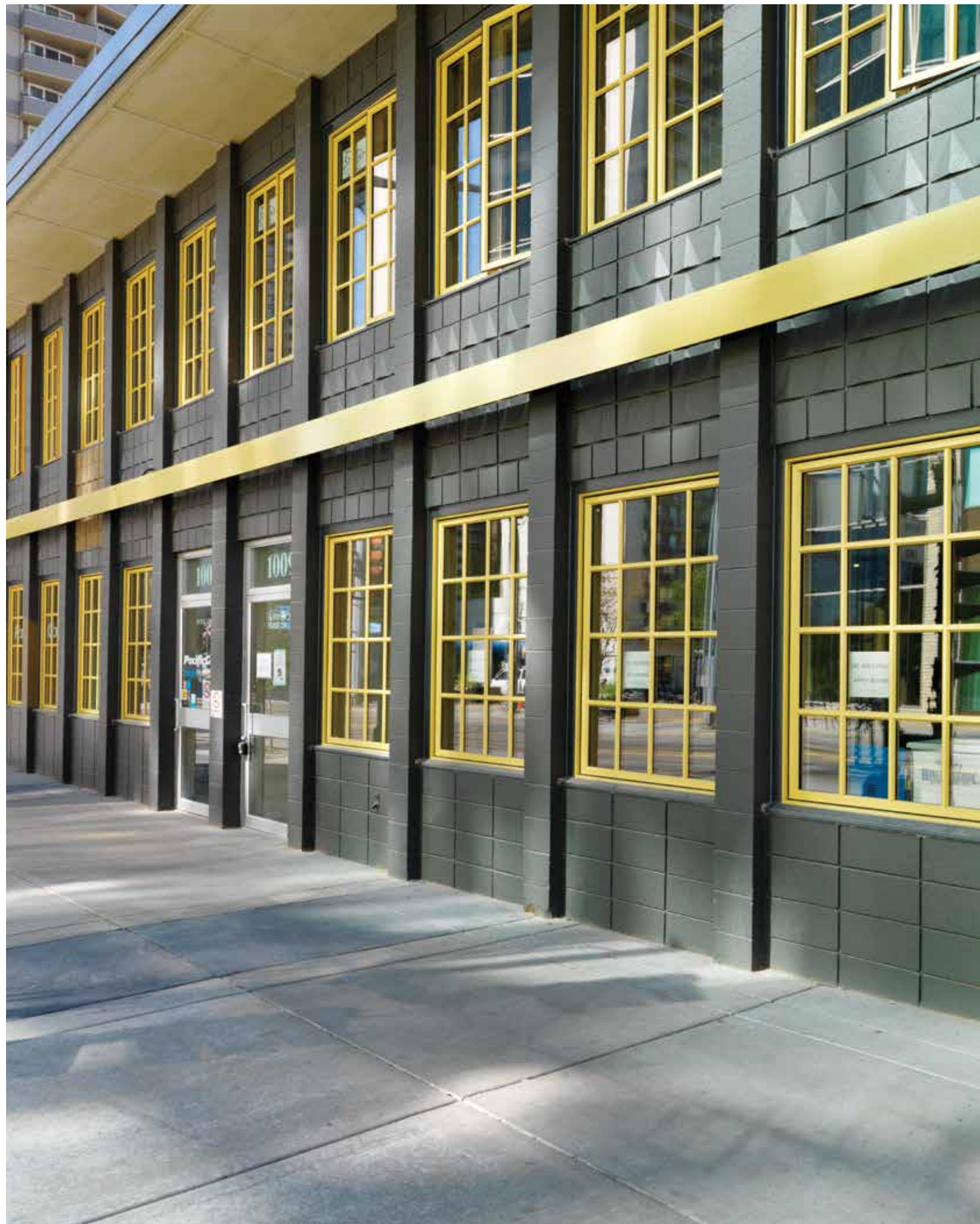



WARRANTIES & AFFILIATIONS

Excellence you can see.
Lux customers enjoy
total peace-of-mind,
confident our products
and services will stand
the test of time.

Look
Inside to
Find

PEACE-OF-MIND
WARRANTIES

INDUSTRY
AFFILIATIONS



Peace-of-Mind Warranties

Lux offers an industry-leading 25 year warranty and a 5 year warranty on installation related labour and warranty materials.

EXTERIOR METAL CLADDING

Lux will provide a limited 25 year warranty from the date of manufacture against flaking, peeling or blistering of the surface finish.

PVC (VINYL) EXTRUSIONS

Lux Windows and Glass provides a limited 25 year warranty from the date of manufacture against defects in materials and workmanship. Within the first 2 years from the date of manufacture, Lux Windows and Glass will replace or repair defective materials at no charge.

INSULATING GLASS WARRANTY

Lux Windows and Glass sealed units are warranted against seal failure for a period of 25 years, to the original consumer and from the date of manufacture. Installation charges apply after two years from the date of installation.

FIBERGLASS DOORS

Lux Windows and Glass provides a limited 10 year warranty against warping or delamination for our fiberglass doors. This coverage is valid from the date of purchase, applicable solely to the original consumer and provided if the door has not been altered in size.

INTERIOR & EXTERIOR WOOD COMPONENTS

Due to natural variations in wood, Lux does not warranty wood components that are exposed to the elements—such as those on the exterior of a home—in either their natural, stained or painted condition.

OPERATING HARDWARE

Lux Windows and Glass provides a limited lifetime warranty on all operating hardware. All Truth Hardware products are warranted against defects in materials and workmanship for the life of the product.

INSTALLATION BY LUX WINDOWS & GLASS CERTIFIED INSTALLERS

When windows and doors are installed by Lux Certified Installers, a limited 5 year warranty is provided from the date of installation against defects in workmanship.



Crafted for
Canada's Climate

A warranty you can count on. Our customers enjoy total peace-of-mind, confident our pioneering products and services will stand the test of time.



Industry Affiliations, Certifications & Memberships

Like you, we only work with the best.

We are proud to be members of our industry's most prestigious associations and strive to exceed their impressive standards through innovation and teamwork.



ENERGY STAR products save money by reducing overall annual energy costs through superior craftsmanship. To qualify for ENERGY STAR designation, windows and doors must meet specific energy efficiency levels that have been set for the three climate zones in Canada. All products are certified by an independent third party and manufacturers who wish to sell ENERGY STAR qualified windows and doors must agree to an administrative arrangement with Natural Resources Canada's Office of Energy Efficiency to encourage the development of the ENERGY STAR brand and its products.



QAI LABORATORIES INC. is a leader in certification, testing and inspections of products for manufacturers and retailers. Their registered certification logo provides officials and consumers assurance that products certified by QAI meet the standards referenced on the label.



THE CANADIAN HOME BUILDERS' ASSOCIATION – CALGARY REGION is one of our country's most established and respected associations representing single and multi-family builders, renovators, land developers, trades, suppliers and industry professionals. These organizations are bound together to provide the Calgary region with housing and communities that represent innovation and integrity. As a proud member of the CHBA – Calgary Region, Lux Windows is one of the 660+ members who strive to continually improve the residential construction industry.



THE ALBERTA CONSTRUCTION SAFETY ASSOCIATION'S vision is to make, through a cooperative effort, the construction environment in Alberta the safest anywhere. Lux Windows has earned a "Certificate of Recognition (COR)" and is committed to maintaining a safe workplace through proven work practices and due diligence.



FENESTRATION CANADA represents and supports all aspects of the window and door manufacturing industry, including formulating and promoting high standards of quality in manufacturing, design, marketing, distribution, sales and application of all types of window and door products.



THE ASSOCIATION OF PROFESSIONAL ENGINEERS AND GEOSCIENTISTS OF ALBERTA (APEGA) regulates the practices of engineering and geoscience in Alberta. The Association's authority is derived from the Engineering and Geoscience Professions Act.



THE CALGARY CONSTRUCTION ASSOCIATION is comprised of contractors and parties who have interests in the building and construction industry throughout the Calgary district. Lux Windows and Glass Ltd. is proud to be a member of this Association and shares its goal of promoting excellence and honorable practice.



HABITAT FOR HUMANITY CALGARY builds affordable homes in partnership with the community and the families for whom they are intended. As a Key Partner, we are proud to donate windows and doors, plus countless volunteer hours, to this visionary organization, and have welcomed the opportunity to help provide warm, safe homes for local families in need.



THE BETTER BUSINESS BUREAU OF SOUTHERN ALBERTA offers information and dispute resolution services to consumers and businesses. Lux Windows and Glass Ltd. is a proud member and continues to hold an outstanding track record.



BUILT GREEN™ adds value to new home construction by promoting and recognizing the use of practices and products that represent resource-efficient and environmentally friendly construction. An industry-driven, volunteer program, Built Green™ benefits the homebuyer, the community and the environment by creating opportunities for everyone to choose a "green" future.



THE CALGARY APARTMENT ASSOCIATION provides a voice for the residential rental industry, and provides professional services and learning opportunities for its members. As a proud member of the Calgary Apartment Association, Lux offers products and services to many of the over 40,000 residential units that are represented within the Association.



CALGARY ITALIAN SPORTSWOMEN'S DINNER ASSOCIATION – Lux Windows proudly supports the CISDA— an organization that provides scholarships to young women of Italian heritage who demonstrates excellence in athletics, academics, leadership, fine arts and volunteerism.

A LASTING IMPRESSION

Windows & Doors

Trust your home to the most complete
line of windows and doors available
anywhere in Western Canada, and to the
unparalleled Lux service commitment.



Lux Windows and Glass Ltd.

lux@luxwindows.com

—
CALGARY SHOWROOM

6875 - 9th Street NE
Calgary, Alberta T2E 8R9

403.276.7770

—
EDMONTON SHOWROOM

18439 - 104th Avenue
Edmonton, Alberta T5S 2V8

780.483.7776

—
luxwindows.com



.....
PHOTOGRAPHY BY JOHN GAUCHER IMAGES

PHOTOGRAPHY LOCATIONS INCLUDE: ALLOY HOMES, ARCURI HOMES, BANFF CARIBOU LODGE, BELL TOWER CONSTRUCTION, CALIFORNIA HOMES, CANTERRA CUSTOM HOMES, CASTLE MOUNTAIN HOMES ELEGANT HOMES, LARATTA HOMES, LASK HOMES, LUPI CONSTRUCTION, MANHATTAN PROJECTS, MCKINLEY MASTERS CUSTOM HOMES, O2 DEVELOPMENTS, RIVERSIDE DEVELOPMENT, SF HOMES LTD, TRADEMARK RENOVATIONS, URBAN DOMAS.

*PRODUCTS AND COLOURS ARE SUBJECT TO CHANGE WITHOUT NOTICE. PLEASE CONTACT A LUX CONSULTANT FOR DETAILS.
.....

